

Project:	
Type:	
Description:	

MOOD PRO ADJUSTABLE SMALL 2.00"

INDOOR - RECESSED

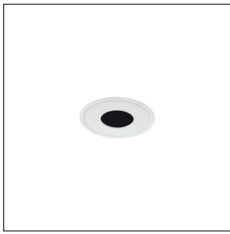

Mood Pro Adjustable Round Trim

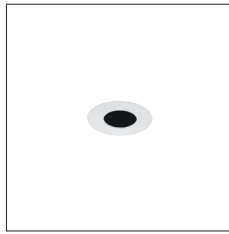

Mood Pro Adjustable Round Trimless

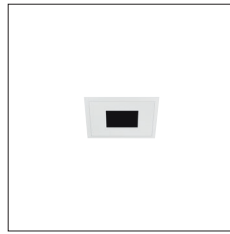

Mood Pro Adjustable Square Trim

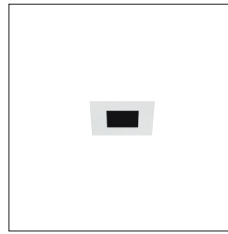

Mood Pro Adjustable Square Trimless

Damp on Request	DRY	Recycling	ETL US	5
-----------------	-----	-----------	--------	---



Round: $\phi 2.28"$ | 58mm
Square: 2.28"x2.28" | 58x58mm



0.07"-0.98" | 2-25mm
Max Ceiling Thickness

LIGHT ENGINE

Example:

A.GP12B.HW12



Lights

- GP1** Round Trim
- LP1** Round Trimless
- MP1** Square Trim
- PP1** Square Trimless

LED Wattage

Z 8.5W

Optics

- B** 9° Narrow
- E** 23° Medium
- H** 30° Wide

CCT

8.5W

- HW** 2700K CRI>90 lm 781
- HQ** 3000K CRI>90 lm 836
- WQ** 3500K CRI>90 lm 860
- HN** 4000K CRI>90 lm 902

Finishes

- 12** Textured matte white
- 31** Textured matte black

Lumens shown above are source.
For delivered lumens, refer to last page.
Lumen maintenance: L90 B10 =50,000h

NOTES

- Consult factory for lead time and pricing
- For alternate ceiling thickness consult factory
- Special finishes (on request)

HOUSING/DRIVER (RETROFIT OPTIONS ARE AVAILABLE, CONSULT FACTORY)

Example:

G.OMOODS.C.0700



Dimming

G Universal Driver
0-10V / Triac / ELV

Housing/Driver Location

- O** New construction housing
Remote/Semi-Remote Driver
- A** IC/AT/CP Housing with
Remote Driver

Plate

- C** Round plate
- Q** Square plate

Current Setting

.0700 8.5W

(A.EM.MOOD.S000) Emergency on request

Project:	
Type:	
Description:	

MOOD PRO ADJUSTABLE SMALL 2.00"

INDOOR - RECESSED

Technical Info

Housing/Driver:

Driver can be located fully remote driver adjacent to fixture in plenum (depending on the driver selected) and is provided with a new construction housing for mounting. Optional additional IC/AT/CP housing with remote driver.

Optical features Light source features:

1 LED/3step/50,000 hrs
 Beam angles: 9°, 23°, 30°
 No interchangeable optics

Physical features:

Material: Die-cast aluminum
 Mountings: Recessed
 Surfaces: Ceiling
 Weight: 0.20lbs

Max Remote Driver Distance:

60 Ft, 18 Ga
 80 Ft, 16 Ga
 100 Ft, 14 Ga

Luminaire Description:

Trim Features: LED and heat sink assembly are followed by an optical reflector determining beam degree, and available accessories. Plate is included with trim.
Trim Benefits: Available in trimless and visible trim, round and square.

Max Fixture Total Wattage: 8.5W

Warranty: 5 Year LED warranty.

ETL listed, Union assembled

Reggiani reserves the right to change details at any time.

Rev08/02/2024

Technical Drawings

LIGHT ENGINE

Round Trim

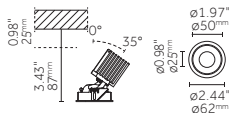

Square Trim

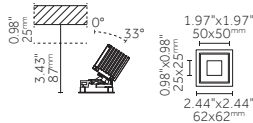

Round Trimless

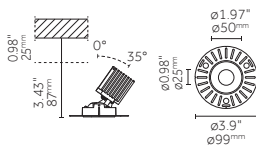

Square Trimless

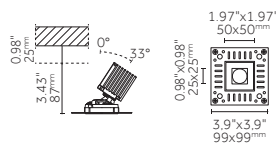

HOUSING/DRIVER

New Construction Housing

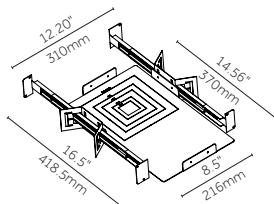

- Requires 1/2" clearance from building members, 3" clearance from any insulation
- Where no minimum install height indicated, minimum height is the trim height plus 1/2"
- Hanger bars install on all 4 sides, expand from 13.5" to 24"
- Hanger brackets accept FB bars, C-Channel, and 1/2" conduit for mounting
- Non electrical housings allow fixture positioning for post ceiling installation.

IC/AT/CP Housing Large

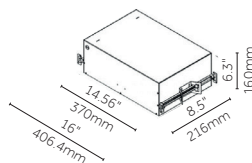

- Requires 1/2" clearance from building members
- Hanger bars expand from 13.5" to 24", add 3.75" to the basic dimension of the housing
- Hanger brackets accept FB bars, C-Channel, and 1/2" conduit for mounting

Remote Driver

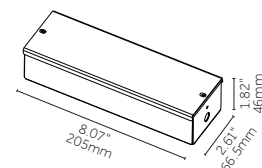

- Must be installed in an accessible serviceable location with maximum 90 degrees Fahrenheit temperature.
- Requires 3" clearance from any insulation

Project:	
Type:	
Description:	

MOOD PRO ADJUSTABLE SMALL 2.00"

INDOOR - RECESSED

Optics accessories

	Description Honeycomb louvre	Code <u>0.26029.0000</u>
---	--	------------------------------------

	Description Colored glass filter 1 mm	Code <u>0.26076.004A</u> <u>0.26076.005A</u> <u>0.26076.006A</u> <u>0.26076.006A</u> <u>0.26076.008A</u> <u>0.26076.009A</u>
	Colour: 4A Red 7A Pink 5A Green 8A Yellow 6A Blue 9A Orange	



	Description Selective filter	Code <u>0.26076.004B</u> <u>0.26076.005B</u> <u>0.26076.006B</u> <u>0.26076.006B</u> <u>0.26076.008B</u> <u>0.26076.009B</u>
	Kelvin: 4B 3000K - 2700K 7B 2700K - 2000K 5B 2700K - 2500K 8B 3000K - 3500K 6B 2700K - 2200K 9B 3000K - 4000K	

Plate accessories

	Description Transparent glass, Damp	Code <u>0.26023.0000</u>
---	---	------------------------------------

	Description Opal lens, Damp	Code <u>0.26031.0000</u>
---	---------------------------------------	------------------------------------

	Description Elliptical beam lens, Damp	Code <u>0.26024.0000</u>
---	--	------------------------------------

	Description Honeycomb louvre for plate	Code <u>0.26036.0000</u>
---	--	------------------------------------

	Description Spread lens, Damp	Code <u>0.26009.0000</u>
---	---	------------------------------------

	Description Snoot (for round)	Code <u>0.26208.0000</u>
---	--	------------------------------------

	Description Snoot (for square)	Code <u>0.26224.0000</u>
---	---	------------------------------------

	Description Snoot with diffusive lens Damp (for round)	Code <u>0.26211.0000</u>
---	---	------------------------------------



	Description Snoot with diffusive lens Damp (for square)	Code <u>0.26227.0000</u>
---	--	------------------------------------

Plate Round Flush

	Description Flush round plate Damp	Code <u>0.26252.0012</u> <u>0.26252.0031</u>
	Finishes: 12 Textured matte white / 31 Textured matte black	

	Description Flush square plate Damp	Code <u>0.26253.0012</u> <u>0.26253.0031</u>
	Finishes: 12 Textured matte white / 31 Textured matte black	

Example:

G.OMOODS.C.0700

Constant Current LED Drivers for Mood Pro S

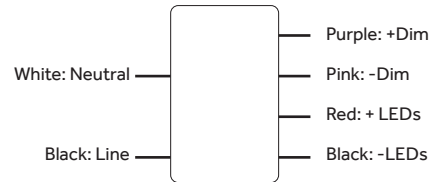
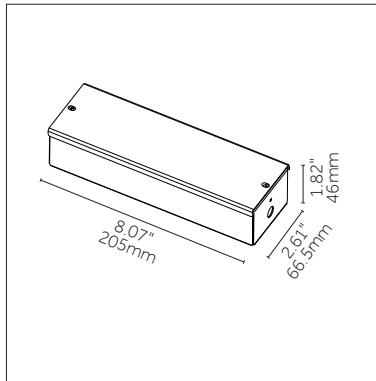
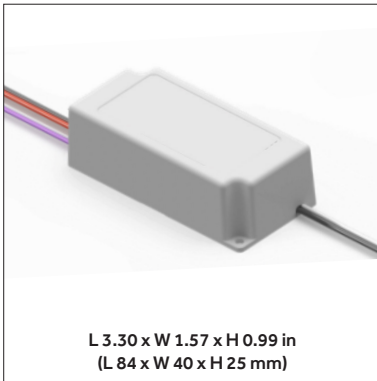

Nominal Input Voltage	Max. Output Power	Output Voltage	Output Current	Efficiency	Max. Case Temperature	THD	Power Factor	Dimming Method	Dimming Range	Startup Time
120 to 277 Vac, 47 - 63 Hz	9 W	8 to 13 Vdc	700 mA CC	up to 87% typical	90°C (measured at the hot spot)	< 20%	> 0.9	Forward-Phase, Reverse-Phase & 0 - 10V	1 - 100% (% of Iout)	300 ms typical

FEATURES

- Compatible with TRIAC (forward-phase or leading-edge), ELV (reverse-phase or trailing-edge) and 0-10 V dimmers
- TRIAC and ELV dimming only at 120 Vac.
- Lifetime: 50,000 hours min at 70°C case temperature
- Protections: output open load, over-current and short-circuit (hiccup), and over-temperature with auto recovery
- Conducted and radiated EMI: Compliant with FCC CFR Title 47 Part 15 Class B (120 Vac)/Class A (277 Vac) and EN55015 (CISPR 15) at 220/230/240 Vac
- Complies with ENERGY STAR® luminaire specification and DLC (DesignLight Consortium®) technical requirements
- IP64-rated case with silicone-based potting.
- 90°C maximum case hot spot temperature
- UL8750 recognized Class 2
- CAN/CSA C22.2 No. 250.13-14 LED equipment for lighting applications

APPLICATIONS

- Downlights
- Commercial & Residential lighting
- Architectural lighting

COMPATIBLE PHASE-CUT DIMMERS & DIMMING RANGE

120Vac Dimmers

Mfg.	Model	Mfg.	Model	Mfg.	Model
Lutron	S-603PG	Lutron	DVELV-303P	Lutron	CT-103P
Leviton	IPI06-1LZ	Lutron	SELV-300P	Cooper	SLC03P
Leviton	6631-2	Leviton	6683-IW	Leviton	IPE04
Lutron	DVCL-153P	Leviton	6161	Lutron	MAELV-600
Lutron	DV-600P	Leviton	6633-P	Lutron	FAELV-500
Lutron	TGCL-153P	Lutron	TG-600P	Lightolier	ZP260QEW
Lutron	S-600P	Cooper	DLC03P	Cooper	DAL06P
Leviton	VPE06	Lutron	LG-600P		

Installation Guide Mood Pro

Warning

- Carefully read these instructions before assembling the Fixture, to assure its correct and safe working performance.
- Keep these instructions in a safe place for future consultation; contact your distributor in the event of malfunction.
- Do not modify the Fixture. Modifying the Fixture in any way invalidates the guarantee of conformity with standards and directives in force and it could make the actual Fixture hazardous. Reggiani will not be responsible for any damage or injury due through misuse of product.
- The Fixture must be installed by qualified experts in accordance with industry best practice.
- System is intended for installation in accordance with National Electric Code, and local regulations. Consult with local inspector to assure compliance.
- As a safety guarantee, any components damaged while the Fixture is operating must be replaced with the same components before it is used again.
- Turn off power at main switch before installing or modifying the system to prevent the risk of fire, electrical shock and injuries to persons.
- Warning: [Risk of fire] do not install insulation within 3 inches around fixture, or junction box, or in a manner to entrap heat.

General Features of Non-Electrical Open New construction housing

- Reggiani offers a diverse size selection of Non-Electrical New construction housing that vary in size depending on the Fixture dimensions and Fixture wattage.
- Non-Electrical New construction housing are provided with two hanger bars that mount on the sides with two screws (provided). Hanger bars expand from 16" to 24". Hanger bars accept FB bars, C-Channel, and 1/2" conduit for mounting.
- Non-Electrical New construction housing are constructed from galvanized steel.

Non-Electrical New construction housing Installation

- Unpack New construction housing, Hanger bars (Typ. 2) and hanger bars screws (Typ. 4) from enclosed packaging. [Fig. 1]
- Identify hanger bar mounting holes on all sides of the Non-Electrical New construction housing. [Fig. 2]
- Identify the orientation of the Non-Electrical New construction housing based on any interference during mounting. [Fig. 3]
- Secure hanger bars to Non-Electrical New construction housing by first ensuring the hanger bar securement tab are oriented towards the bottom of the Non-Electrical New construction housing. [Fig. 4]
- Secure hanger bars with provided hardware. [Fig. 5]
- Extend hanger bars between joists. Hanger bars can be adjusted to accommodate joist centers between 16" to 24". Hammer in securement tabs into ceiling joist. [Fig. 6]
- Permanently secure hanger bars to joist with hardware provided by others. [Fig. 7]
- Extend wiring from output of Remote driver to New construction housing. Leave enough slack so the wiring extends through the housing and out of the ceiling cut-out plane by 6" to facilitate servicing of the light engine.

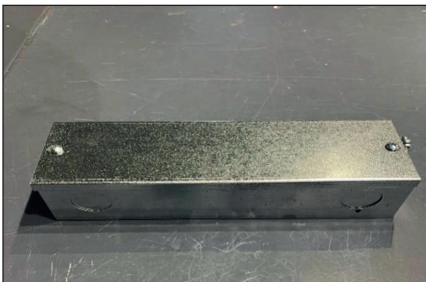

Fig. 1

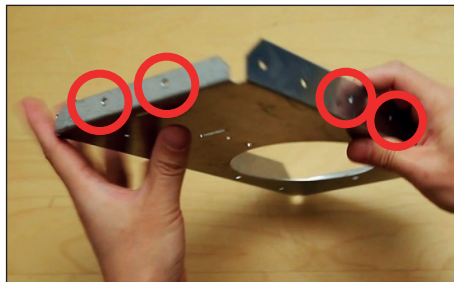

Fig. 2

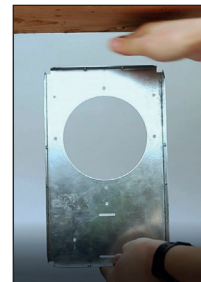

Fig. 3

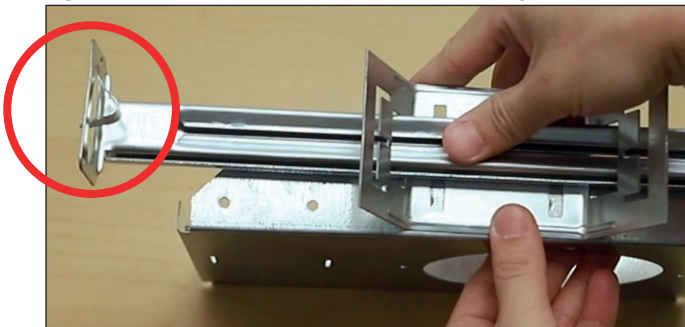

Fig. 4



Fig. 5

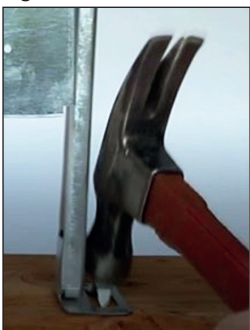

Fig. 6

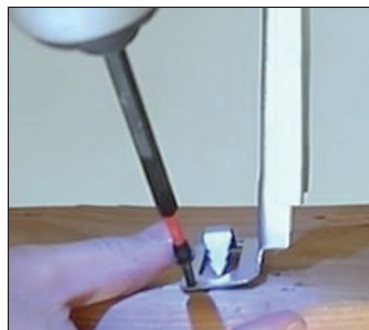

Fig. 7

Installation Guide Mood Pro

Warning

- Carefully read these instructions before assembling the Fixture, to assure its correct and safe working performance.
- Keep these instructions in a safe place for future consultation; contact your distributor in the event of malfunction.
- **Do not modify the Fixture. Modifying the Fixture in any way invalidates the guarantee of conformity with standards and directives in force and it could make the actual Fixture hazardous. Reggiani will not be responsible for any damage or injury due through misuse of product.**
- The Fixture must be installed by qualified experts in accordance with industry best practice.
- System is intended for installation in accordance with National Electric Code, and local regulations. Consult with local inspector to assure compliance.
- As a safety guarantee, any components damaged while the Fixture is operating must be replaced with the same components before it is used again.
- **Turn off power at main switch before installing or modifying the system to prevent the risk of fire, electrical shock and injuries to persons.**
- Warning: [Risk of fire] do not install insulation within 3 inches around fixture, or junction box, or in a manner to entrap heat.

Wiring

- The driver supplied with the Fixture is specially designed to maximize performance. Unless the Reggiani engineering department issues specific authorization, use of other drivers is prohibited.
- For non-track Fixtures, Fixture is provided with either remote driver, semi-remote driver, or integral driver. Note: Before turning on mains power, confirm LED wires are properly connected to driver output wires.
- For remote and semi-remote driver, the correct wiring sequence is to wire the LED to the driver output, then connect the driver input to mains power. Note: if semi-remote option is available, then driver is serviceable through Fixture aperture.
- For integral driver, the wiring between LED and driver output is prewired. The correct wiring sequence is to wire the driver input to mains power.

Dimming

- Below is an overview of the different dimming options Reggiani offers, consult Factory for availability.
- **Phase Cut [Reverse and Forward]**
The luminous flux is dimmed by varying the AC power delivered to the Fixture via Reverse [ELV] and Forward [Triac] phase configurations.
- **Analogue [0-10V]**
The luminous flux is dimmed by varying a 0-10V direct voltage signal through polarity sensitive purple [dim +] and grey [dim -] wiring.
- **Emergency Lighting**
The Fixture can be converted into emergency lighting by wiring to an emergency lighting inverter.

Remote/Semi-Remote Driver Installation

- Note:
- Remote/Semi-Remote driver must be installed in an accessible serviceable location with maximum ambient temperature of 100 degrees Fahrenheit (37 degree Celsius).
- Remote/Semi-Remote driver box requires 3" clearance from any insulation.
- The LED drivers are secured in a metal enclosure with standard 1/2" trade size knock-outs.
- From the specification sheet or Fixture cutsheet determine the wiring method, series or parallel, and the number of Fixtures per driver for the model.
- For multiple Fixtures powered to one driver via parallel circuit, connect all positive low voltage wires [fixtures and driver] to a common splice point and same with the negative.
- For multiple Fixtures powered to one driver via series circuit, each Fixture is to connect to the next by alternating polarity. See example wiring below.

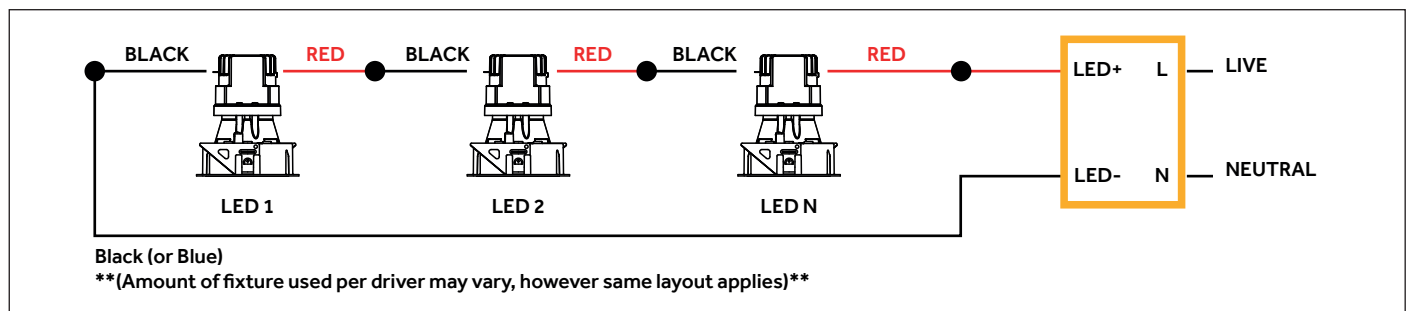

- Maximum driver distance from Remote/Semi-Remote driver to Fixture is as follows:

Wire Gauge	Distance [ft]
18GA	60'
16GA	80'
14GA	100'

- Identify Remote/Semi-Remote driver and Z Brackets. [Fig. 6]
- Bring building mains power wires to Remote/Semi-Remote driver box through side knock-out. [Fig. 7]
- Remove Remote/Semi-Remote driver box cover, exposing driver input and output wires. [Fig. 8]
- Connect building wires to LED driver input wires as such: white to white [neutral], black to black [hot], and green to green/bare [ground]. [Fig. 9]
- Through appropriate methods, extend Remote/Semi-Remote driver output wires to Fixture ceiling junction box in preparation to connect with Fixture LED (+) and LED (-) wires.
- Secure Remote/Semi-Remote driver on flat surface via provided Z Brackets (Typ. 2) [Fig. 6]. Depending on field condition, use appropriate screws to secure Z Brackets on driver box and flat surface. [Fig. 10]
- Alternately, the Remote/Semi-Remote driver metal enclosure may be secured onto surface using hardware by others. First remove driver enclosure cover plate, fasten sheet metal screw through metal enclosure and onto surface, and then reattach driver enclosure cover plate.

Installation Guide Mood Pro

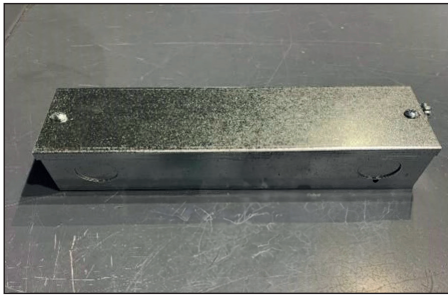

Fig. 6 - Remote/Semi-remote Driver



Fig. 7 - Knock-out

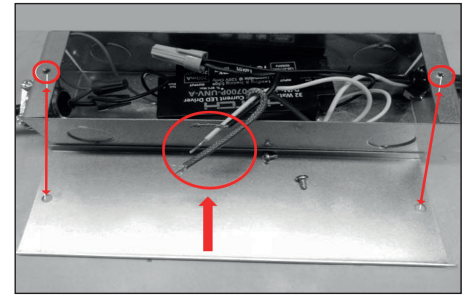

Fig. 8



Fig. 9



Fig. 10

Ceiling Preparation for Fixture

- Use the following chart to appropriately cut out the hole in the ceiling for the Fixture.
- Tolerance: $\pm 1/16$ inch

Table A: Ceiling Cut Out Dimensions (inches)

Fixture Model	XS	S	M	L	XL
Adjustable - Round Flush	N/A	2.30	3.6	4.80	6.50
Adjustable - Round Cone	N/A	N/A	3.6	4.80	6.50
Adjustable - Square Flush	N/A	2.30 x 2.30	3.60 x 3.60	4.80 x 4.80	6.50 x 6.50
Adjustable - Square Pyramid	N/A	N/A	3.60 x 3.60	4.80 x 4.80	6.50 x 6.50
Fixed - Round	1.50	2.30	3.6	4.80	6.50
Fixed - Square	1.50 x 1.50	2.30 x 2.30	3.60 x 3.60	4.80 x 4.80	6.50 x 6.50
Fixed - Round w/ Dome	1.50	2.30	3.6	4.80	N/A
Fixed - Round w/ Cylinder	1.50	2.30	3.6	4.80	N/A
Wall Washer - Round	N/A	2.30	3.6	4.80	6.50
Wall Washer - Round Drop	N/A	2.30	3.6	4.80	6.50
Wall Washer - Square	N/A	2.30 x 2.30	3.60 x 3.60	4.80 x 4.80	6.50 x 6.50
Wall Washer - Square Drop	N/A	2.30 x 2.30	3.60 x 3.60	4.80 x 4.80	6.50 6.50

- Depending on the Mood shape and size, there may be different mounting spring clips. Refer to the following Spring Clip Table before Fixture installation.

Fixture Installation: Trimless Version

- Adjustable (S, M, L, XL). Fixed (XS, S, M, L, XL). Wall Washer (S, M, L, XL)

- Note: Installation of Remote/Semi-Remote driver and extended low voltage wiring must be completed prior to Fixture installation.
- Make the appropriately sized cut out hole in the ceiling, see Table A: Ceiling Cut Out Dimensions.
- Connect previously extended Remote/Semi-Remote driver output wires to Fixture LED (+) (Red) and LED (-) (Black) wires.
- Insert Fixture into ceiling cut out and use provided screws to fix in place.
- Finish with plaster, smoothing it evenly around the mud flange.

Fixture Installation: Trim Version

- Adjustable (S, M, L, XL). Fixed (XS, S, M). Wall Washer (S, M, L, XL)

- Note: Fixture mounting clips accommodates 5/8-inch ceiling thickness. Installation of Remote/Semi-Remote driver and extended low voltage wiring must be completed prior to Fixture installation.
- Make the appropriately sized cut out hole in the ceiling, see Table A: Ceiling Cut Out Dimensions.
- Connect previously extended Remote/Semi-Remote driver output wires to Fixture LED (+) (Red) and LED (-) (Black) wires.
- Secure mounting spring clips (see Table B: Spring Clip Table) and then push Fixture into the ceiling cut-out.

- Fixed (L, XL)

- Note: All Fixture mounting clips accommodates a minimum of 5/8-inch ceiling thickness. Installation of Remote/Semi-Remote driver and extended low voltage wiring must be completed prior to Fixture installation.
- Make the appropriately sized cut out hole in the ceiling, see Table A: Ceiling Cut Out Dimensions.
- Connect previously extended Remote/Semi-Remote driver output wires to Fixture LED (+) (Red) and LED (-) (Black) wires.
- Remove Fixture faceplate.
- Secure Fixture in place by tightening screw in wing.
- Reinstall Fixture faceplate.

Installation Guide Mood Pro

TRIM INSTALLATION

(Mood Pro Adjustable, Fixed, Wall Washer)

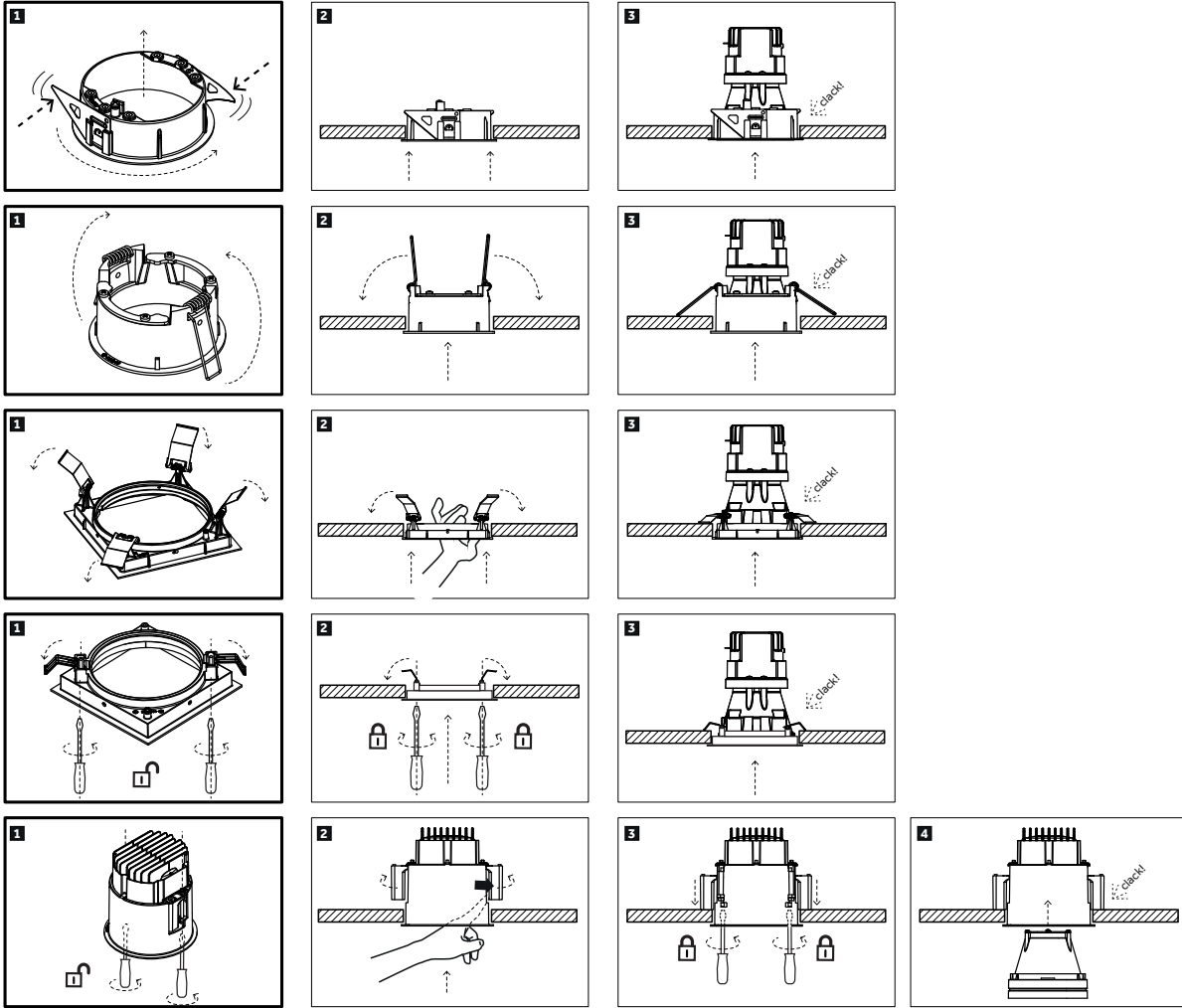

TRIMLESS INSTALLATION

(Mood Pro Adjustable, Fixed, Wall Washer)

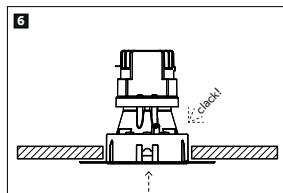
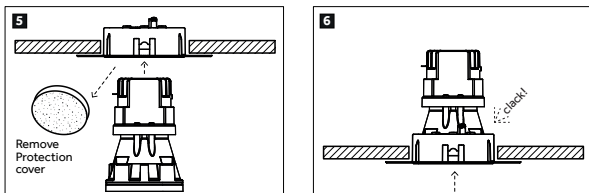
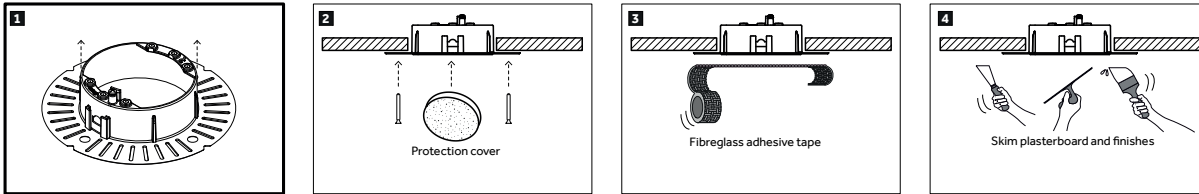

ADJUSTMENT

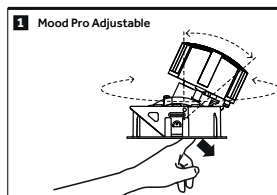
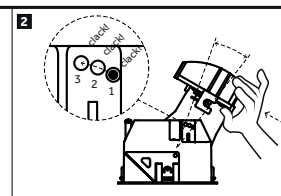
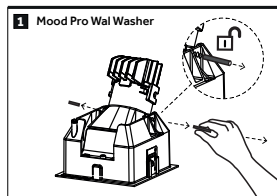

Installation Guide Mood Pro

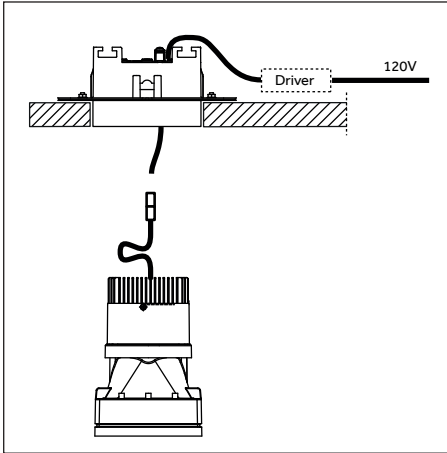

Fig. 1

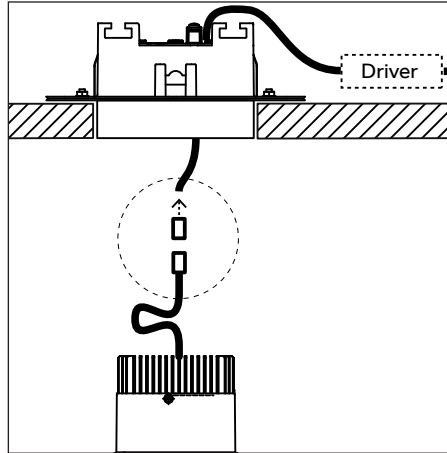

Fig. 2

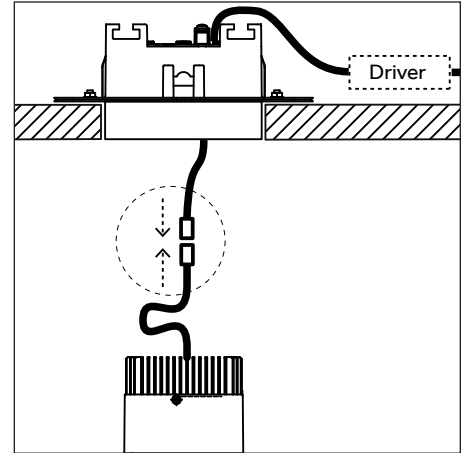

Fig. 3

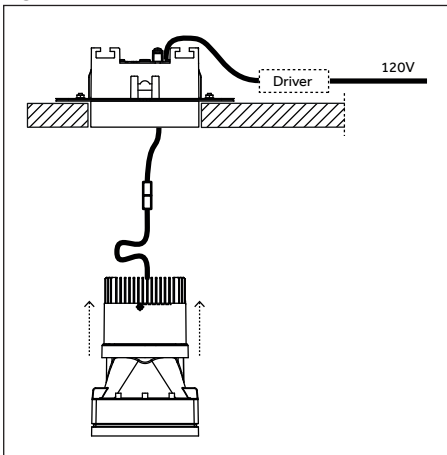

Fig. 4