

Project:	
Type:	
Description:	

YORI 1LT. RECESSED 2.4"

INDOOR - RECESSED

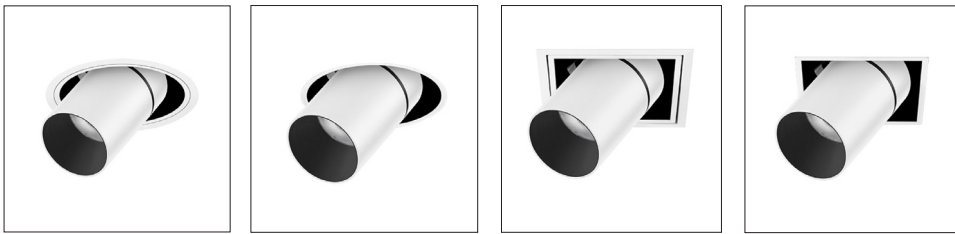

Yori 1Lt Round Trim

Yori 1Lt Round Trimless

Yori 1Lt Square Trim

Yori 1Lt Square Trimless



Round: Ø 5.4"
Square: 5.4"x5.4"



1 1/4in Max Ceiling Thickness

Precision = Refractor Optics
Performance = Reflector Optics

LIGHT ENGINE

Power LED Very Narrow Optic

Example:

A . **5** **2** **A** . **12** **A.TM52A.HW12**

Trim

- TM Round Trim
- UM Round Trimless
- KM Square Trim
- XM Square Trimless

Optic Type

5 Precision

Wattage

2 9W

Optics

A Precision 8°

CCT

9W

- HW 2700K CRI>90 lm 725
- HQ 3000K CRI>90 lm 730
- WW 3000K CRI>80 lm 845
- WN² 3500K CRI>80 lm 893
- NN 4000K CRI>80 lm 940

Finishes

- 12 Embossed matt white
- 31 Embossed matt Black

NOTES

1. For alternate ceiling thickness consult factory
2. For 3500K CCT, must consult with factory to confirm availability

All lumens shown above are source.
Lumen delivered up to 770 lm Precision
Lumen maintenance: L90 B10=50,000h

COB LED Standard Optics

Example:

A . **5** **3** **B** . **12** **A.BM52E.HW12**

Trim

- BM Round Trim
- CM Round Trimless
- GM Square Trim
- HM Square Trimless

Optic Type

5 Precision
6 Performance

Wattage

2 9W
3 12W

Optics

- B Precision 12°
- E Precision 20°
- H Precision 32°
- B Performance 13°
- E Performance 24°
- H Performance 40°

CCT

9W/12W

- HW 2700K CRI>90 lm 1050/1370
- HQ 3000K CRI>90 lm 1100/1420
- WW 3000K CRI>80 lm 1300/1700
- WN² 3500K CRI>80 lm 1330/1738
- NN 4000K CRI>80 lm 1360/1775
- HC 3000K CRI>98 lm 960/1252

Finishes

- 12 Embossed matt white
- 31 Embossed matt black

NOTES

1. For alternate ceiling thickness consult factory
2. For 3500K CCT, must consult with factory to confirm availability

All lumens shown above are source.
Lumen delivered up to 1115/1455 lm Precision
Lumen delivered up to 1200/1560 lm Performance
Lumen maintenance: L80 B10=50,000h

Warm Dimming COBLED

Example:

A . **5** **3** **B** . **DT** **A.BM53B.DT12**

Trim

- BM Round Trim
- CM Round Trimless
- GM Square Trim
- HM Square Trimless

Optic Type

5 Precision

Wattage

3 12W

Optics

B Precision 27°

CCT

12W

DT 1700-3000K CRI>95 lm 100-1000

Finishes

- 12 Embossed matt white
- 31 Embossed matt black

NOTES

1. For alternate ceiling thickness consult factory

All lumens shown above are source.
Lumen delivered up to 690 lm Precision
Lumen maintenance: L90 B10=50,000h

Project:	
Type:	
Description:	

YORI 1LT. RECESSED 2.4"

INDOOR - RECESSED

HOUSING/DRIVER (RETROFIT OPTION AVAILABLE, CONSULT FACTORY)

Example:

T.OMH71.137C

Dimming	Housing/Driver Location	Driver Code	Plate
T Phase-Cut	Open Housing with Remote/Semi-remote Driver	120V; Phase-cut, dims down to 1%, powers 1 fixture at a time	137C Round plate
		120V; Phase-cut, dims down 1%, powers 1 fixture at a time	136S Square plate
	9W- A OPTIC ONLY	120V; Phase-cut, dims down to 10%, powers 1 fixture at a time	
V 0-10V		120/277V; 0-10V, dims down 1%, powers 1 fixture at a time	
		120/277V; 0-10V, dims down 1%, powers 1 fixture at a time	
	9W- A OPTIC ONLY	120/277V; 0-10V, dims down 1%, powers 1 fixture at a time, Remote Driver Only	
L Lutron EcoSystem		120/277V; Lutron EcoSystem Soft-on, Fade-to-Black, dims down to 0.1%, powers 1 fixture at a time	
		120/277V; Lutron EcoSystem Soft-on, Fade-to-Black, dims down to 0.1%, powers 1 fixture at a time	
	9W- A OPTIC ONLY	120/277V; Lutron EcoSystem Soft-on, Fade-to-Black, dims down to 0.1%, powers 1 fixture at a time	

NOTES
3. For emergency driver options, consult factory

Technical Info

Housing/Driver:

Driver can be located fully remote or semi-remote adjacent to fixture in plenum (depending on the driver selected) and is provided with an open housing for mounting.

Optical/Light source features:

2 LED/3step/50,000 hrs

Beam angles:

Precision: 8°, 12°, 20°, (27° only for warm- dim DT option)

Performance: 13°, 24°, 40°

Physical features:

Material: Die-cast aluminum

Mounting: Recessed

Surface: Ceiling

Weight: 2 lbs

Max remote driver distance:

60 Ft, 18Ga

80 Ft, 16Ga

100 Ft, 14 Ga

Luminaire Description:

Fixture Features: Light engine can be completely hidden inside the ceiling plane and function as a down light, or may be pulled out below the ceiling plane and adjusted up to 90° vertically and 358° horizontally. The attractive Yori cylinder is die cast aluminum with powder coat finish. Quickly changes beam spreads through the use of Precision refractors or Performance reflectors and various accessories.

Fixture Benefits: Part of the Yori family of lights assures consistent design. Serves as a down light, wall wash, or accent light without compromise.

Max Fixture Total Wattage:

9W LED: 12W

12W LED: 15W

Accessories: Wide range of Precision and Performance accessories available

ETL listed, Union assembled

Max Ceiling Thickness: 1.25 in

Warranty: 5 Year LED.

Reggiani reserves the right to change details at any time.
Rev 8/10/2021

Project:	
Type:	
Description:	

YORI 1LT. RECESSED 2.4" INDOOR - RECESSED

TECHNICAL DRAWINGS

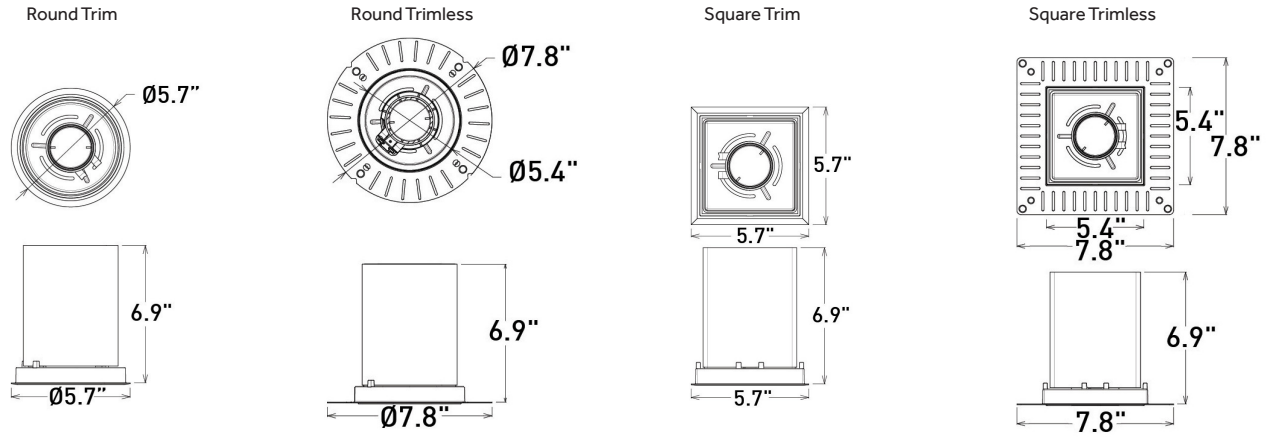

HOUSING/DRIVER

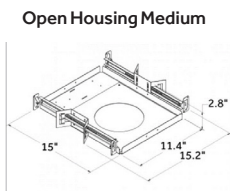

FOR USE WITH: MH19 Driver



FOR USE WITH: MH74, MH71, MH70, MH73, ML121, ML156, and ML112 Drivers

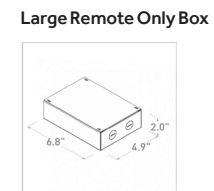

FOR USE WITH: MZ22 Driver

1. Requires 1/2" clearance from building members, 3" clearance from any insulation
2. Where no minimum install height indicated, minimum height is the trim height plus 1/2"
3. Hanger bars install on all 4 sides, expand from 13.5" to 24"
4. Hanger brackets accept FB bars, C-Channel, and 1/2" conduit for mounting
5. Non electrical housings allow fixture positioning for post ceiling installation

1. Must be installed in an accessible serviceable location with maximum 90 degrees Fahrenheit temperature.
2. Requires 3" clearance from any insulation

1. Must be installed in an accessible serviceable location with maximum 90 degrees Fahrenheit temperature.
2. Requires 3" clearance from any insulation

1. Must be installed in an accessible serviceable location with maximum 90 degrees Fahrenheit temperature.
2. Requires 3" clearance from any insulation

Project:	
Type:	
Description:	

YORI 1LT. RECESSED 2.4"

INDOOR - RECESSED

ACCESSORIES PRECISION











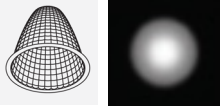
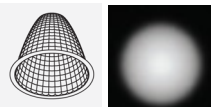





	Description: Precision - Narrow beam (12°-9W, 12W) (27°-For warm-dim only)	Code: 0.35125.0000	
	Description: Precision - Medium beam (20°-9W, 12W)	Code: 0.35126.0000	
	Description: Precision - Wide beam (32°-9W, 12W)	Code: 0.35127.0000	
	Description: Glass filter 1 mm	Code: 0.26402.00__	Finishes: 4A RED 5A Green 6A Blue 7A Pink 8A Yellow 9A orange
	Description: Colored Gel Slides (2 pieces)	Code: 0.26410.0000	
	Description: Selective filter 3000K - 2700K	Code: 0.26559.0000	
	Description: Selective filter 2700K - 2500K	Code: 0.26418.0000	
	Description: Selective filter 2700K - 2200K	Code: 0.26426.0000	
	Description: Selective filter 2700K - 2000K	Code: 0.26434.0000	
	Description: Selective filter 3000K - 3600K	Code: 0.26567.0000	
	Description: Selective filter 3000K - 4000K	Code: 0.26575.0000	
	Description: Dense texture honeycomb louvre	Code: 0.26442.0000	
	Description: Wide texture honeycomb louvre	Code: 0.26450.0000	
	Description: Elliptical beam lens	Code: 0.26457.0000	
	Description: Opal lens	Code: 0.26462.0000	
	Description: Spread lens	Code: 0.26470.0000	
	Description: Cross blade louvre	Code: 0.26477.0000	
	Description: Barn doors	Code: 0.26485.0000	
	Description: Cone 45° wall washer	Code: 0.26489.00__	Finishes: 12 White 31 Black

Project:	
Type:	
Description:	

YORI 1LT. RECESSED 2.4"

INDOOR - RECESSED

ACCESSORIES PERFORMANCE

	Description: Performance - Narrow beam (13°-9W, 12W)	Code: 0.35145.0000	
	Description: Performance - Medium beam (24°-9W, 12W)	Code: 0.35146.0000	
	Description: Performance - Wide beam (40°-9W, 12W)	Code: 0.35147.0000	
	Description: Glass filter 1 mm	Code: 0.26403.00__	Finishes: 4A RED 5A Green 6A Blue 7A Pink 8A Yellow 9A orange
	Description: Colored Gel Slides (2 pieces)	Code: 0.26411.0000	
	Description: Selective filter 3000K - 2700K	Code: 0.26560.0000	
	Description: Selective filter 2700K - 2500K	Code: 0.26419.0000	
	Description: Selective filter 2700K - 2200K	Code: 0.26427.0000	
	Description: Selective filter 2700K - 2000K	Code: 0.26435.0000	
	Description: Selective filter 3000K - 3600K	Code: 0.26568.0000	
	Description: Selective filter 3000K - 4000K	Code: 0.26576.0000	
	Description: Dense texture honeycomb louvre	Code: 0.26443.0000	
	Description: Wide texture honeycomb louvre	Code: 0.26451.0000	
	Description: Elliptical beam lens	Code: 0.26493.0000	
	Description: Opal lens	Code: 0.26463.0000	
	Description: Spread lens	Code: 0.26471.0000	
	Description: Cross blade louvre	Code: 0.26481.0000	
	Description: Cone 45° wall washer	Code: 0.26497.00__	Finishes: 12 White 31 Black