

Project:	
Type:	
Description:	

YORI 2LT. OVAL RECESSED 3.7" INDOOR - RECESSED

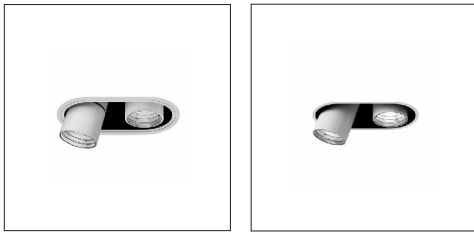

Yori 2 Lt Oval Trim Yori 2 Lt Oval Trimless



Oval: 6.2 x 11.5in



1 1/4in Max Ceiling Thickness

Precision = Refractor Optics
Performance = Reflector Optics

LIGHT ENGINE Example:

COB LED Very Narrow Optic

A . **5** **4** **A** . **A.9M54A.HW12**

Trim	Optic Type	Wattage	Optics	CCT	Finishes
9M Oval Trim	5 Precision	4 17Wx2	A Precision 7°	17Wx2 HW 2700K CRI>90 lm 1870x2 HQ 3000K CRI>90 lm 1920x2 WW 3000K CRI>80 lm 2320x2 WN² 3500K CRI>80 lm 2360x2 NN 4000K CRI>80 lm 2400x2 HC 3000K CRI>98 lm 1700x2	12 Embossed matt white 31 Embossed matt Black
EM Oval Trimless					

NOTES
1. For alternate ceiling thickness consult factory
2. For 3500K, must consult with factory to confirm availability.

All lumens shown above are source.
Lumen delivered up to 1510lm Precision
Lumen maintenance: L90B10=50,000h

COB LED Standard Optics Example:

A . . **A.7M53E.HW12**

Trim	Optic Type	Wattage	Optics	CCT	Finishes
7M Oval Trim	5 Precision	3 12 Wx2	B Precision 12° E Precision 24° B Performance 10° E Performance 20° H Performance 31° M Performance 40°	12Wx2/17Wx2 HW 2700K CRI>90 lm 1491x2/2067x2 HQ 3000K CRI>90 lm 1533x2/2122x2 WW 3000K CRI>80 lm 1859x2/2582x2 WN² 3500K CRI>80 lm 1890x2/2624x2 NN 4000K CRI>80 lm 1920x2/2665x2 HC 3000K CRI>98 lm 1323x2/1834x2	12 Embossed matt white 31 Embossed matt black
8M Oval Trimless	6 Performance	4 17 Wx2			

NOTES
1. For alternate ceiling thickness consult factory
2. For 3500K, must consult with factory to confirm availability.

All lumens shown above are source.
Lumen delivered up to 1690x2/2350x2 Precision
Lumen delivered up to 1800x2/2500x2 Performance
Lumen maintenance: L70B50=50,000h

Project:	
Type:	
Description:	

YORI 2LT. OVAL RECESSED 3.7" INDOOR - RECESSED

HOUSING/DRIVER (RETROFIT OPTION AVAILABLE, CONSULT FACTORY)

Example:

T.OLH62.159V

Dimming	Housing/Driver Location	Driver Code	Plate
T Phase-Cut	Open Housing with Remote/Semi-remote Driver	120V, Phase-cut, dims to 1%, powers 1 fixture at a time	159V Oval Plate
		12Wx2 LH100	
		17Wx2 LH62	
V 0-10V		120/277V, 0-10V, dims to 0.1%, powers 1 fixture at a time	
		12Wx2 LD49	
		17Wx2 LD50	
L Lutron EcoSystem		120/277V, Lutron EcoSystem Soft-on, fade to black, dims down to 0.1%, powers 1 fixture at a time	
		12Wx2 LL121	

NOTES
3. For emergency driver options, consult factory

Project:	
Type:	
Description:	

YORI 2LT. OVAL RECESSED 3.7"

INDOOR - RECESSED

Technical Info

Housing/Driver:

Driver can be located fully remote or semi-remote adjacent to fixture in plenum and is provided with an open housing for mounting.

Optical/Light source features:

2 LED/3step/50,000 hrs

Beam angles:

Precision: 7°, 12°, 24°

Performance: 10°, 20°, 31°

Physical features:

Material: Die-cast aluminum

Mounting: Recessed

Surface: Ceiling

Weight: 6.4 lbs

Max remote driver distance:

60 Ft, 18Ga

80 Ft, 16Ga

100 Ft, 14 Ga

Luminaire Description:

Fixture Features: Light engine can be completely hidden inside the ceiling plane and function as a down light, or may be pulled out below the ceiling plane and adjusted up to 90° vertically and 358° horizontally. The attractive Yori cylinder is die cast aluminum with powder coat finish. Quickly changes beam spreads through the use of Precision refractors or Performance reflectors and various accessories.

Fixture Benefits: Part of the Yori family of lights assures consistent design. Serves as a down light, wall wash, or accent light without compromise.

Max Fixture Total Wattage:

24W LED: 30W

34W LED: 40W

Accessories: Wide range of Precision and Performance accessories available ETL listed, Union assembled

Max Ceiling Thickness: 1-1/4"

Warranty: 5 Year LED.

Reggiani reserves the right to change details at any time.

Rev 8/10/2021

TECHNICAL DRAWINGS

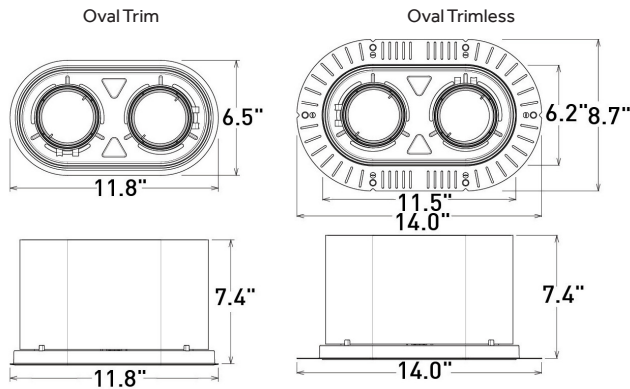

HOUSING/DRIVER

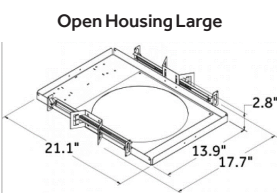

Large Remote/
Semi-Remote Box

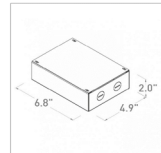

FOR USE WITH: LH100, LL121, LD49,
LH62, and LD50 Drivers

1. Requires 1/2" clearance from building members, 3" clearance from any insulation
2. Where no minimum install height indicated, minimum height is the trim height plus 1/2"
3. Hanger bars install on all 4 sides, expand from 13.5" to 24"
4. Hanger brackets accept FB bars, C-Channel, and 1/2" conduit for mounting
5. Non electrical housings allow fixture positioning for post ceiling installation











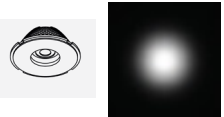
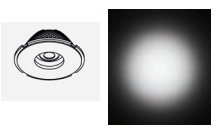





1. Must be installed in an accessible serviceable location with maximum 90 degrees Fahrenheit temperature.
2. Requires 3" clearance from any insulation

Project:	
Type:	
Description:	

YORI 2LT. OVAL RECESSED 3.7"

INDOOR - RECESSED

ACCESSORIES PRECISION













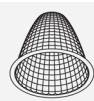

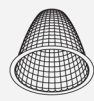
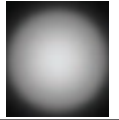
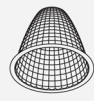
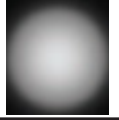





	Description: Precision - Narrow beam (12°-12W, 17W, 24W)	Code: 0.35135.0000	
	Description: Precision - Medium beam (24°-12W, 17W, 24W)	Code: 0.35136.0000	
	Description: Glass filter 1 mm	Code: 0.26406.00__	Finishes: 4A RED 5A Green 6A Blue 7A Pink 8A Yellow 9A orange
	Description: Colored Gel Slides (2 pieces)	Code: 0.26414.0000	
	Description: Selective filter 3000K - 2700K	Code: 0.26563.0000	
	Description: Selective filter 2700K - 2500K	Code: 0.26422.0000	
	Description: Selective filter 2700K - 2200K	Code: 0.26430.0000	
	Description: Selective filter 2700K - 2000K	Code: 0.26438.0000	
	Description: Selective filter 3000K - 3600K	Code: 0.26571.0000	
	Description: Selective filter 3000K - 4000K	Code: 0.26579.0000	
	Description: Dense texture honeycomb louvre	Code: 0.26446.0000	
	Description: Wide texture honeycomb louvre	Code: 0.26454.0000	
	Description: Elliptical beam lens	Code: 0.26459.0000	
	Description: Opal lens	Code: 0.26466.0000	
	Description: Spread lens	Code: 0.26474.0000	
	Description: Cross blade louvre	Code: 0.26479.0000	
	Description: Barn doors	Code: 0.26487.0000	
	Description: Cone 45° wall washer	Code: 0.26491.00__	Finishes: 12 White 31 Black

Project:	
Type:	
Description:	

YORI 2LT. OVAL RECESSED 3.7"

INDOOR - RECESSED

ACCESSORIES PERFORMANCE

		Description: Performance - Narrow beam (10°-12W, 17W, 24W)	Code: 0.35155.0000	
		Description: Performance - Medium beam (20°-12W, 17W, 24W)	Code: 0.35156.0000	
		Description: Performance - Wide beam (31°-12W, 17W, 24W)	Code: 0.35157.0000	
		Description: Performance - Wide beam (40°-12W, 17W, 24W)	Code: 0.35158.0000	
		Description: Glass filter 1 mm	Code: 0.26407.00__	Finishes: 4A RED 5A Green 6A Blue 7A Pink 8A Yellow 9A orange
		Description: Colored Gel Slides (2 pieces)	Code: 0.26415.0000	
		Description: Selective filter 3000K - 2700K	Code: 0.26564.0000	
		Description: Selective filter 2700K - 2500K	Code: 0.26423.0000	
		Description: Selective filter 2700K - 2200K	Code: 0.26431.0000	
		Description: Selective filter 2700K - 2000K	Code: 0.26439.0000	
		Description: Selective filter 3000K - 3600K	Code: 0.26572.0000	
		Description: Selective filter 3000K - 4000K	Code: 0.26580.0000	
		Description: Dense texture honeycomb louvre	Code: 0.26447.0000	
		Description: Wide texture honeycomb louvre	Code: 0.26455.0000	
		Description: Elliptical beam lens	Code: 0.26495.0000	
		Description: Opal lens	Code: 0.26467.0000	
		Description: Spread lens	Code: 0.26475.0000	
		Description: Cross blade louvre	Code: 0.26483.0000	
		Description: Cone 45° wall washer	Code: 0.26499.00__	Finishes: 12 White 31 Black