

Project:	
Type:	
Description:	

TRYBECA RECESSED 3" INDOOR - RECESSED

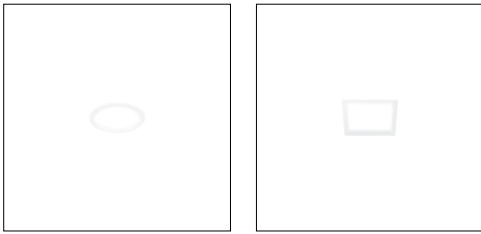

Trybeca Round
Trim / Trimless

Trybeca Square
Trim / Trimless

CUT OUT
 Round: ø3.3" | 85mm
 Square: 3.3"x3.3" | 85x85mm

0.07"-1.37" | 2-35mm
 Max Ceiling Thickness

LIGHT ENGINE Example:

A					A.BH1C0.HW12
Lights	LED Wattage	Optics	CCT	Finishes	
<ul style="list-style-type: none"> BH1 Round Trim CH1 Round Trimless DH1 Square Trim FH1 Square Trimless 	<ul style="list-style-type: none"> C 8W 3 9W only for DT 	<ul style="list-style-type: none"> 0 Very Wide 	<ul style="list-style-type: none"> HW 2700K CRI >90 lm 900 HQ 3000K CRI >90 lm 936 WQ 3500K CRI >90 lm 1110 HN 4000K CRI >90 lm 1116 DT: 1800-2700K CRI >90 lm 31-900 <p>Lumens shown above are source. Lumen maintenance: L80 B10 =50,000h (DT: L80 B10 =50,000h)</p>	<ul style="list-style-type: none"> 12 Textured matte white 31 Textured matte black 	
<ul style="list-style-type: none"> BC0 Round Trim CC0 Round Trimless DC0 Square Trim FC0 Square Trimless 					

- NOTES
- Warm Dim fixtures are 9W (A.BC03.DT12) on request
 - Consult factory for lead time and pricing
 - For alternate ceiling thickness consult factory

HOUSING/DRIVER (RETROFIT OPTIONS ARE AVAILABLE, CONSULT FACTORY) Example:

G					G.OTRY3.C.0500
Dimming	Housing/Driver Location	Plate	Current Setting		
<ul style="list-style-type: none"> G Universal Driver 0-10V / Triac / ELV 	<ul style="list-style-type: none"> O New construction housing Remote/Semi-Remote Driver A IC/AT/CP Housing with Remote Driver 	<ul style="list-style-type: none"> TRY3 C Round plate Q Square plate 	<ul style="list-style-type: none"> .0500 9W .0250 (DT¹) 		

- NOTES
- (A.EM.TRYB.3) Emergency on request
- Warm Dim fixtures on request

Project:	
Type:	
Description:	

TRYBECA RECESSED 3"

INDOOR - RECESSED

Technical Info

Housing/Driver:

Remote driver is required and provided with an new construction housing for mounting.
Optional additional IC/AT/CP housing.

Optical features Light source features:

1 LED/3step/50,000 hrs

Beam angles: Depends on diffuser position

Physical features:

Material: Die-cast aluminum
Mounting: Recessed Mounting
Surfaces: Ceiling
Weight: 0.5 lbs

Maximum Driver Distance:

60 Ft, 18Ga
80 Ft, 16Ga
100Ft, 14 Ga

Luminaire Description:

Trim Features: Available regressed, flush, or dropped.

Trim Benefits: Polycarbonate diffuser Nano Surface Treated for excellent LOR up to 87%. Internal reflector projects downlight while illuminating diffuser. Trim or trimless version. Requires remote Class 2 driver. Remote driver to be mounted in an accessible location. Above ceiling access required.

Max Fixture Total Wattage: 8W; 9W DT

Accessories: Depth clips included for all three lens positions, regardless of the installed position selected.

Max Ceiling thickness: 0.07"-1,37" | 2-35mm

Warranty: 5 Year LED.

ETL listed, Union assembled

Reggiani reserves the right to change details at any time.

When powering multiple fixtures per driver, consult factory for additional components as required.

Rev 11/03/2024

Technical Drawings

LIGHT ENGINE

Round Trim

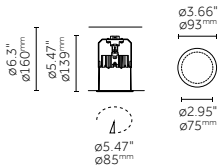

Square Trim

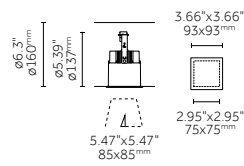

Diffuser Positions

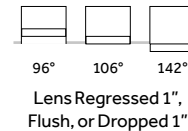

Round Trimless

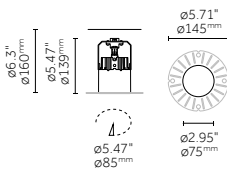

Square Trimless

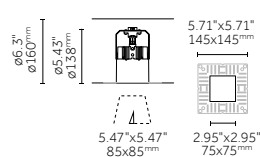

HOUSING/DRIVER

New Construction Housing

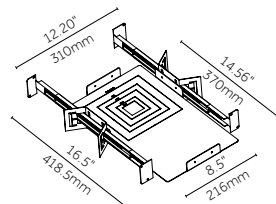

- Requires 1/2" clearance from building members, 3" clearance from any insulation
- Where no minimum install height indicated, minimum height is the trim height plus 1/2"
- Hanger bars install on all 4 sides, expand from 13.5" to 24"
- Hanger brackets accept FB bars, C-Channel, and 1/2" conduit for mounting
- Non electrical housings allow fixture positioning for post ceiling installation.

IC/AT/CP Housing Large

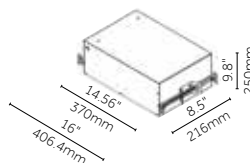

- Requires 1/2" clearance from building members
- Hanger bars expand from 13.5" to 24", add 3.75" to the basic dimension of the housing
- Hanger brackets accept FB bars, C-Channel, and 1/2" conduit for mounting

Remote Driver

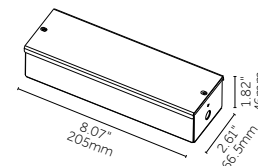

- Must be installed in an accessible serviceable location with maximum 90 degrees Fahrenheit temperature.
- Requires 3" clearance from any insulation

Project:	
Type:	
Description:	

TRYBECA RECESSED 3"

INDOOR - RECESSED

ACCESSORIES



Description

Plastic spacer set/

Code

1.38223.0000

Example:

G.OTRY3.C.0500

Constant Current LED Drivers for Trybeca 3"

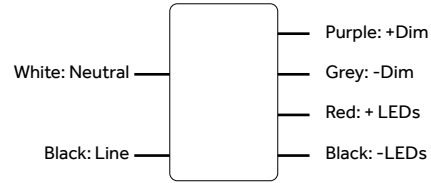
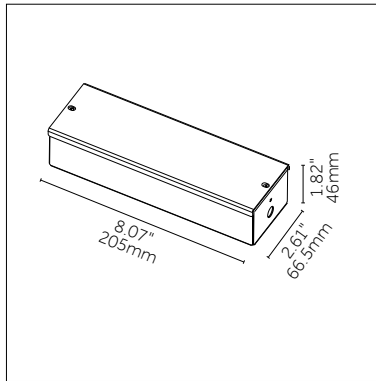
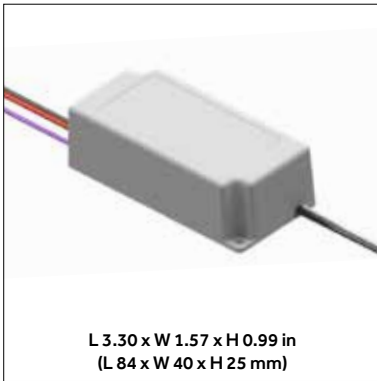

Nominal Input Voltage	Max. Output Power	Output Voltage	Output Current	Efficiency	Max. Case Temperature	THD	Power Factor	Dimming Method	Dimming Range	Startup Time
120 to 277 Vac, 47 - 63 Hz	9 W	10 to 18 Vdc	500 mA CC	up to 87% typical	90°C (measured at the hot spot)	< 20%	> 0.9	Forward-Phase, Reverse-Phase & 0 - 10V	1 - 100% (% of Iout)	400 ms typical

FEATURES

- Compatible with TRIAC (forward-phase or leading-edge), ELV (reverse-phase or trailing-edge) and 0-10 V dimmers
- TRIAC and ELV dimming only at 120 Vac.
- Lifetime: 50,000 hours min at 70°C case temperature
- Protections: output open load, over-current and short-circuit (hiccup), and over-temperature with auto recovery
- Conducted and radiated EMI: Compliant with FCC CFR Title 47 Part 15 Class B (120 Vac)/Class A (277 Vac) and EN55015 (CISPR 15) at 220/230/240 Vac
- Complies with ENERGY STAR® luminaire specification and DLC (DesignLight Consortium®) technical requirements
- IP64-rated case with silicone-based potting.
- 90°C maximum case hot spot temperature
- UL8750 recognized Class 2
- CAN/CSA C22.2 No. 250.13-14 LED equipment for lighting applications

APPLICATIONS

- Downlights
- Commercial & Residential lighting
- Architectural lighting

COMPATIBLE PHASE-CUT DIMMERS & DIMMING RANGE

120Vac Dimmers

Mfg.	Model	Mfg.	Model	Mfg.	Model
Lutron	S-603PG	Lutron	DVELV-303P	Lutron	CT-103P
Leviton	IPI06-1LZ	Lutron	SELV-300P	Cooper	SLC03P
Leviton	6631-2	Leviton	6683-IW	Leviton	IPE04
Lutron	DVCL-153P	Leviton	6161	Lutron	MAELV-600
Lutron	DV-600P	Leviton	6633-P	Lutron	FAELV-500
Lutron	TGCL-153P	Lutron	TG-600P	Lightolier	ZP260QEW
Lutron	S-600P	Cooper	DLC03P	Cooper	DAL06P
Leviton	VPE06	Lutron	LG-600P		





Installation Guide Trybeca

Warning

- Carefully read these instructions before assembling the Fixture, to assure its correct and safe working performance.
- Keep these instructions in a safe place for future consultation; contact your distributor in the event of malfunction.
- Do not modify the Fixture. Modifying the Fixture in any way invalidates the guarantee of conformity with standards and directives in force and it could make the actual Fixture hazardous. Reggiani will not be responsible for any damage or injury due through misuse of product.
- The Fixture must be installed by qualified experts in accordance with industry best practice.
- System is intended for installation in accordance with National Electric Code, and local regulations. Consult with local inspector to assure compliance.
- As a safety guarantee, any components damaged while the Fixture is operating must be replaced with the same components before it is used again.
- Turn off power at main switch before installing or modifying the system to prevent the risk of fire, electrical shock and injuries to persons.
- Warning: [Risk of fire] do not install insulation within 3 inches around fixture, or junction box, or in a manner to entrap heat.

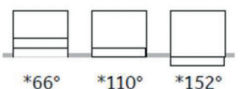
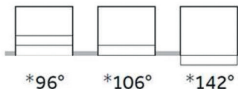
General Features of Trybeca

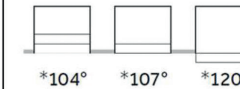
- The Trybeca Recessed range is available in square or round versions and five sizes, each with the same metric, so the luminaires integrate harmoniously with each other.
- For more technical information about the product (photometric, electrical data, size, weight, certification etc.) refer to the catalogue or see the product datasheet on www.reggianiusa.com.

Beam Angle Based on Diffuser Position				
1.5" Trybeca Recessed	3.0" Trybeca Recessed	4.0" Trybeca Recessed	6.0" Trybeca Recessed	12" Trybeca Recessed
 <p>*66° *110° *152°</p>	 <p>*96° *106° *142°</p>	 <p>99° 106° 138°</p>	 <p>*104° *107° *120°</p>	 <p>*106° *110° *116°</p>

Non-Electrical New construction housing Installation

- Unpack New construction housing, Hanger bars (Typ. 2) and hanger bars screws (Typ. 4) from enclosed packaging. [Fig. 1]
- Identify hanger bar mounting holes on all sides of the Non-Electrical New construction housing. [Fig. 2]
- Identify the orientation of the Non-Electrical New construction housing based on any interference during mounting. [Fig. 3]
- Secure hanger bars to Non-Electrical New construction housing by first ensuring the hanger bar securement tabs are oriented towards the bottom of the Non-Electrical New construction housing. [Fig. 4]
- Secure hanger bars with provided hardware. [Fig. 5]
- Extend hanger bars between joists. Hanger bars can be adjusted to accommodate joist centers between 16" to 24". Hammer in securement tabs into ceiling joist. [Fig. 6]
- Permanently secure hanger bars to joist with hardware provided by others. [Fig. 7]
- Extend wiring from output of Remote driver to New construction housing. Leave enough slack so the wiring extends through the housing and out of the ceiling cut-out plane by 6" to facilitate servicing of the light engine.

Installation Guide Trybeca

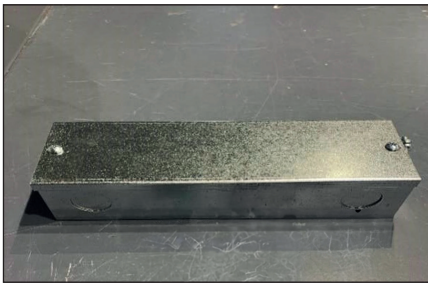

Fig. 1

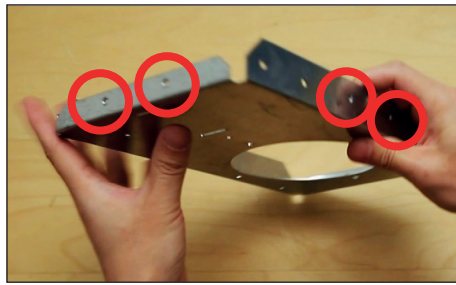

Fig. 2

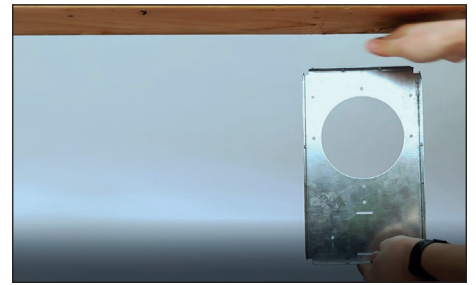

Fig. 3

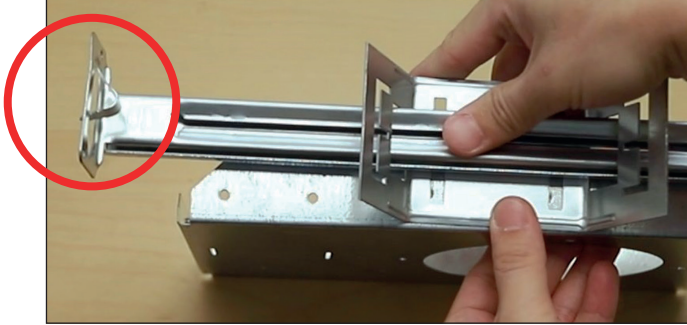

Fig. 4

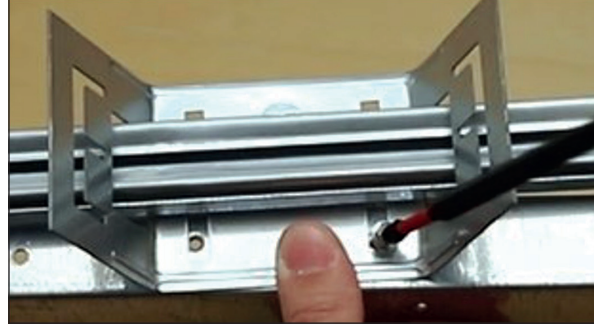

Fig. 5



Fig. 6

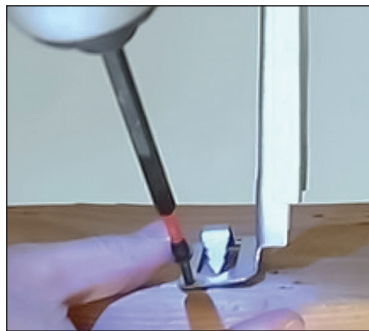

Fig. 7

Preparation and Assembly of the Luminaires

- First assemble plastic spacer. Spacer can accommodate three different diffuser positions (fig. 1).

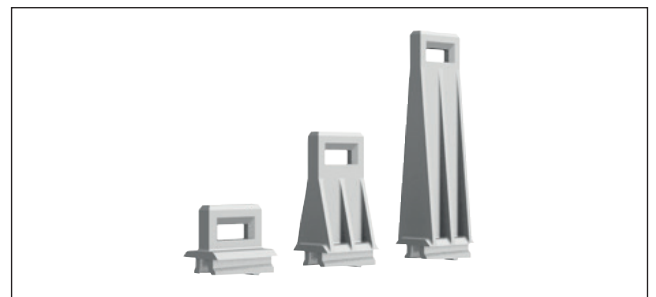
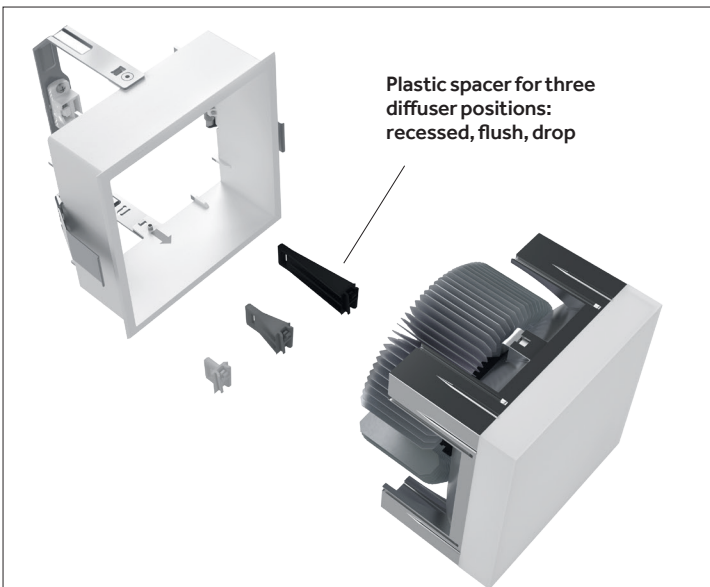

Fig. 1

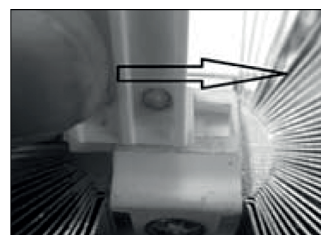

Fig. 2



Fig. 3

Installation Guide Trybeca

- Second, prepare ceiling by cutting out opening according to the following dimensions. (fig. 2)

Ceiling Cut Out Dimensions		
Size	Cut Out (Inch; mm)	Tolerance
Trybeca 1.5" ; 38mm	Round 1.9" ; 47mm Square 1.9" x 1.9" ; 47x 47mm	± 1/16
Trybeca 3.0" ; 75mm	Round 3.3" ; 85mm Square 3.3"x3.3" ; 85x85mm	± 1/16
Trybeca 4.0" ; 100mm	Round 4.37" ; 112x112mm Square 4.37"x4.37" ; 112x112mm	± 1/16
Trybeca 6.0" ; 150mm	Round 6.3" ; 161mm Square 6.3"x6.3" ; 161x161mm	± 1/16
Trybeca 12" ; 300mm	Round Trim 12" ; 315mm Round Trimless 12" ; 315mm Square Trim 12"x12" ; 315x315mm Square Trimless 12"x12" ; 315x315mm	± 1/16

Fig. 2

Trimless Luminaire Installation

- Cut opening in ceiling (fig 1).
- Insert trimless chassis into ceiling cut out (fig 2).
- Install provided screws (x4) into corner locations (fig 3).
- Apply plaster, smoothing it evenly around the trimless flange (fig 4).
- Make electrical connections (fig 9)
- Finish by securing light engine in the trimless chassis.

Trim Luminaire Installation

- Fixture mounting clips may accommodate the following ceiling thicknesses.

Maximum Ceiling Thickness	
Size	Cut Out (Inch; mm)
Trybeca 1.5"	1,37"; 35mm
Trybeca 3.0"	1,37"; 35mm
Trybeca 4.0"	1,37"; 35mm
Trybeca 6.0"	1,37"; 35mm
Trybeca 12"	1,37"; 35mm

- Secure trim chassis into ceiling cut out by pushing down on springs (fig 5).
- Make electrical connections.
- Finish by securing light engine in the trim chassis.

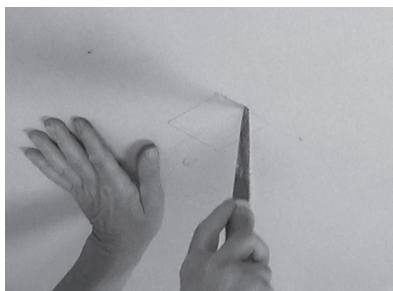

Fig. 1



Fig. 2

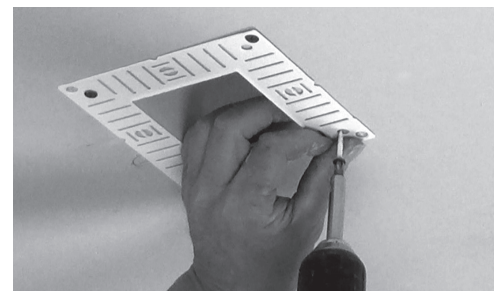

Fig. 3

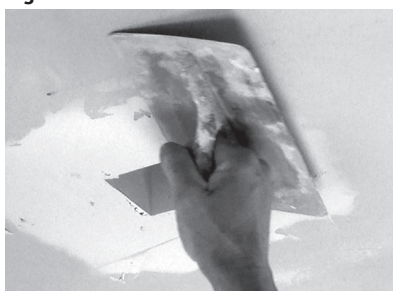

Fig. 4



Fig. 5

Installation Guide Trybeca

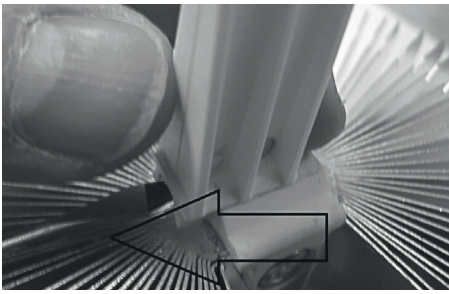

Fig. 1

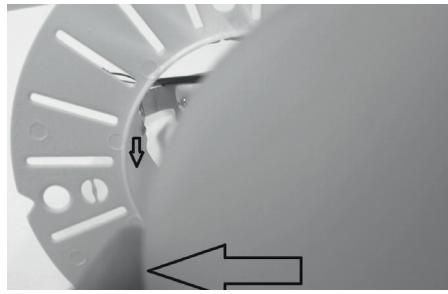

Fig. 2

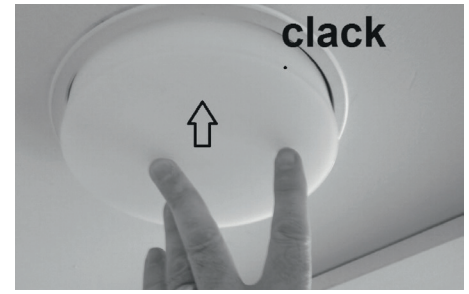

Fig. 3



Fig. 4

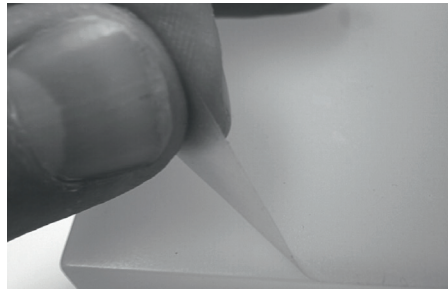

Fig. 5

Remote/Semi-Remote Driver Installation

- Identify Remote/Semi-Remote driver and Z Brackets. [Fig. 6]
- Bring building mains power wires to Remote/Semi-Remote driver box through side knock-out. [Fig. 7]
- Remove Remote/Semi-Remote driver box cover, exposing driver input and output wires. [Fig. 8]
- Connect building wires to LED driver input wires as such: white to white [neutral], black to black [hot], and green to green/bare [ground]. [Fig. 9]
- Through appropriate methods, extend Remote/Semi-Remote driver output wires to Fixture ceiling junction box in preparation to connect with Fixture LED (+) and LED (-) wires.
- Secure Remote/Semi-Remote driver on flat surface via provided Z Brackets (Typ. 2) [Fig. 6]. Depending on field condition, use appropriate screws to secure Z Brackets on driver box and flat surface. [Fig. 10]
- Alternately, the Remote/Semi-Remote driver metal enclosure may be secured onto surface using hardware by others. First remove driver enclosure cover plate, fasten sheet metal screw through metal enclosure and onto surface, and then reattach driver enclosure cover plate.



Fig. 6 - Remote/Semi-remote Driver



Fig. 7 - Knock-out

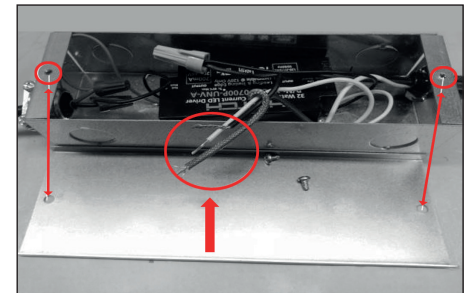

Fig. 8



Fig. 9



Fig. 10

Remote Driver Installation

- Remote driver to be installed in an easily accessible location for future maintenance if necessary.
- Ambient operating range to range from -4 °F to +100 °F.
- Maximum driver distance is as follows.

Maximum Driver Distance	
Wire Gauge	Distance (ft)
18GA	60';
16GA	80';
14GA	100';

Single Fixture Wiring

- In single fixture wiring, one driver operates one fixture.
- Secondary wire between remote driver box and fixture to be provided by others.
- Red wire represents LED +, Black wire represents LED -

Wiring Diagram 2

Home run wiring, single fixture (wired in parallel)

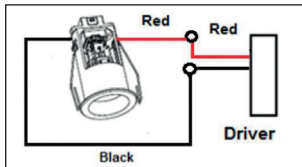

Multiple Fixtures Wired in Series

- Fixtures in series to be wired per the following wire diagram.
- The number of fixtures to be wired in series back to one driver is specified on cutsheet.
- Secondary wire between remote driver box and fixture to be provided by others.
- Red wire represents LED +, Black wire represents LED -

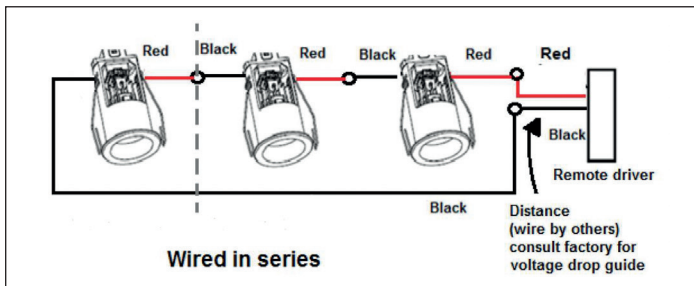

Semi-Remote Driver Installation

Wiring

- The driver supplied with the LED luminaire is specially designed to maximize performance. Unless the Reggiani engineering department issues specific authorization, use of other drivers is prohibited. The correct wiring sequence is to wire the LED to the DRIVER, then connect the DRIVER to mains power. The LED may be permanently damaged if it is wired to the DRIVER when the DRIVER is connected to the mains power supply.

Dimming

- Below is an overview of the different dimming options Reggiani offers, consult Factory for availability.
- **Phase Cut [Reverse and Forward]**
The luminous flux is dimmed by varying the AC power delivered to the Fixture via Reverse [ELV] and Forward [Triac] phase configurations.
- **Analogue [0-10V]**
The luminous flux is dimmed by varying a 0-10V direct voltage signal through polarity sensitive purple [dim +] and grey [dim -] wiring.
- **Emergency Lighting**
The Fixture can be converted into emergency lighting by wiring to an emergency lighting inverter.